

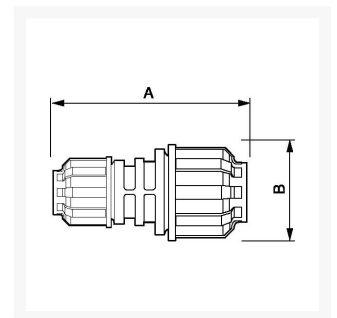

Raccord Réducteur pour tubes Diam. ext. 32 mm vers tube de Diam. ext. 25 mm de réseau air comprimé

Product Images



Référence	9ALRMR3225
EAN	08712418282559
Poids (kg)	0.177000
Longueur (mm)	114
Largeur (mm)	65
Construction	Polyamide
Diamètre Ø (mm)	32 x 25
Pression maximale (bar)	13 à 40°C



Additional Information