

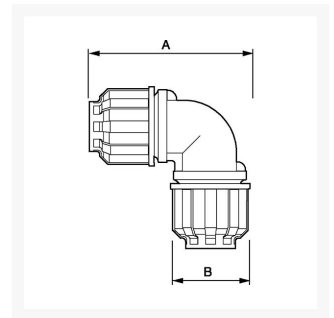

Coude égal 90° pour tubes Diam. Ext. 20 mm pour réseau air comprimé

Product Images



Additional Information

Référence	9ALR9C20
EAN	08712418282573
Poids (kg)	0.102000
Longueur (mm)	83
Largeur (mm)	47
Construction	Polyamide
Diamètre Ø (mm)	20
Pression maximale (bar)	13 à 40°C

