

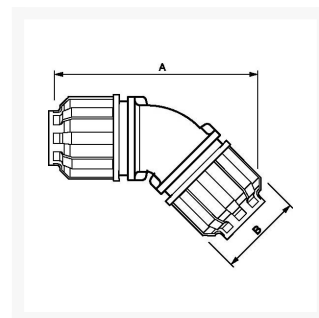

# Coude égal 45° pour tubes Diam. Ext. 25 mm pour réseau air comprimé

## Product Images



## Additional Information

---

Référence	9ALR4C25
EAN	08712418282627
Poids (kg)	0.133000
Longueur (mm)	113
Largeur (mm)	53
Construction	Polyamide
Diamètre Ø (mm)	25
Pression maximale (bar)	13 à 40°C

